

MIN. WALL OPENING

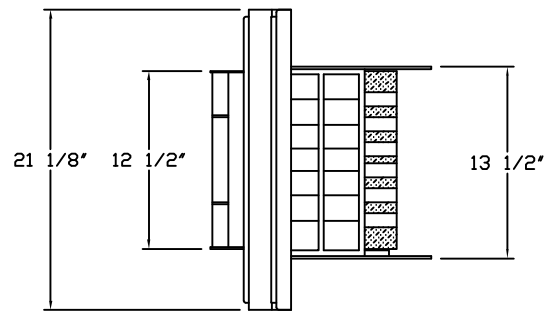

PLAN

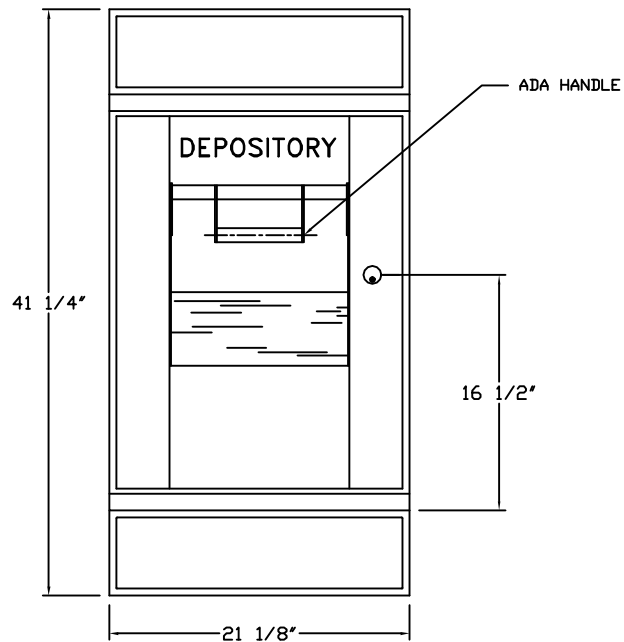

FRONT ELEVATION

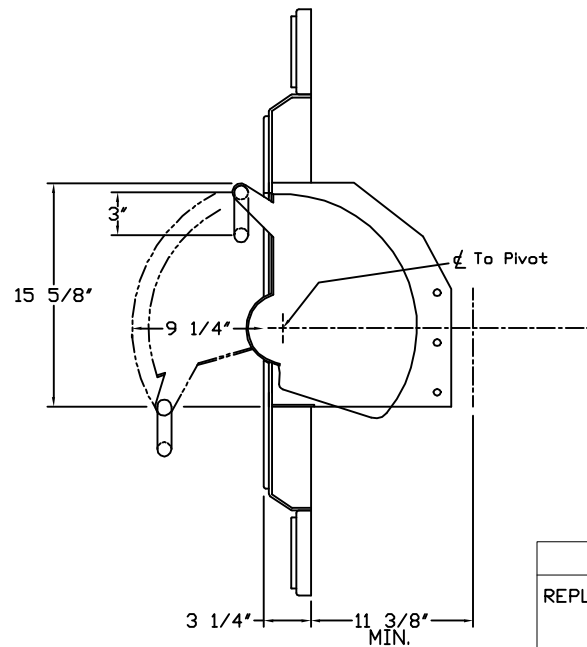

SECTION

HAMILTON SAFE	
REPLACEMENT NIGHT DEPOSITORY MODEL 98RH SHOWN WITH OPTIONAL B6307-1 (6' TRIM TOP & BOTTOM)	
Drawing Number 195-637	Date 19-30-98